

## Ruby 025

Construction materials: **AISI 316 electropolished**

New pump line with a brand new designing that offers reinforced pumping potentials. The updated designing provides even bigger performance provided with economy.

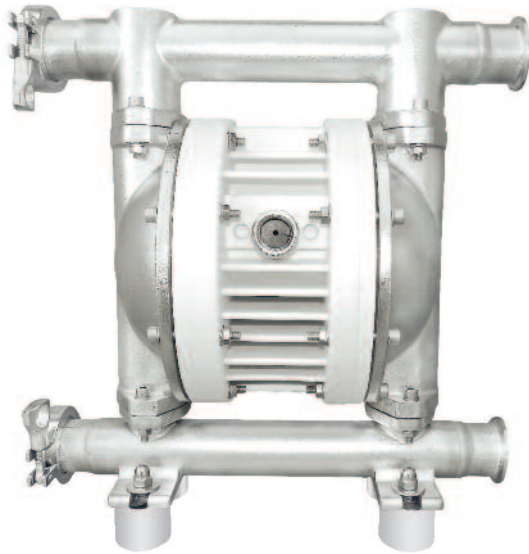

## Benefits

- Optimal performance
- Economical air consumption, ecological designing
- High efficiency for pressure/capacity
- Oil free operation
- No freezing
- New air valve designing, fully controlled air passing
- New generation EPDM diaphragms with embodied inner-outer piston FDA Approved
- Easy disassembling and re-assembling
- New generation PTFE diaphragms of embodied type for long-life operation (compound) FDA Approved
- Advanced quality Full capacity PTFE-A diaphragms FDA Approved
- Easy manifold reverse
- Automatic suction

## Ruby 025 pumps composition codes

Pump model	Body	Center block	Diaphragms	Valve Seats	Balls	O-ring	Other options
Ruby 025	SL: AISI 316 electropolished	W: PP WHITE AN: Alu Nickel Plated	E: EPDM Conductive T: TFM+(EPDM Conductive) Z: TFM-A+(EPDM Conductive)	T: PTFE V: PVDF S: AISI 316	T: PTFE S: AISI 316	T: PTFE	C: Tri Clamp

### Ruby Innovative oil free air valve

The heart of the Ruby pump is our innovative, new design air valve. In respect for New Era demands, to create and offer High Quality product, with high interest for the environment and it's protection, the Air Valve of the Ruby Diaphragm Pumps has been created to offer:

- ✓ Oil free operation
- ✓ Low need for maintenance
- ✓ Not affected by minor contamination of compressed air
- ✓ Significant energy saving
- ✓ Non freezing operation
- ✓ External environment operation
- ✓ No dead centre
- ✓ Long life
- ✓ Reliability

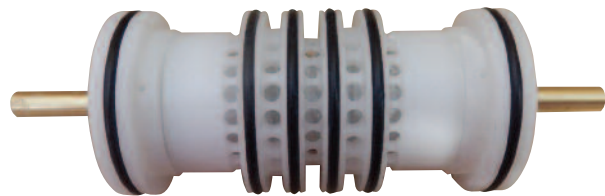

### Advance unified diaphragms featuring:

- ✓ Easy installation and maintenance
- ✓ Excellent service life
- ✓ Inventory cost reduction
- ✓ Improved performance
- ✓ Greater displacement per cycle
- ✓ No center hole, elimination of potential leak paths.
- ✓ There is no need for the main axis to be insured
- ✓ They can be screwed and unscrewed without the use of tools



## Advance Unified Diaphragm offers:

**The prominences decrease** the stretching of the PTFE during the regression and prevent it from cracking.

**Innovative conical shape** ideal for optimal performance and life, low pressure requirements for start-up, ideal suction

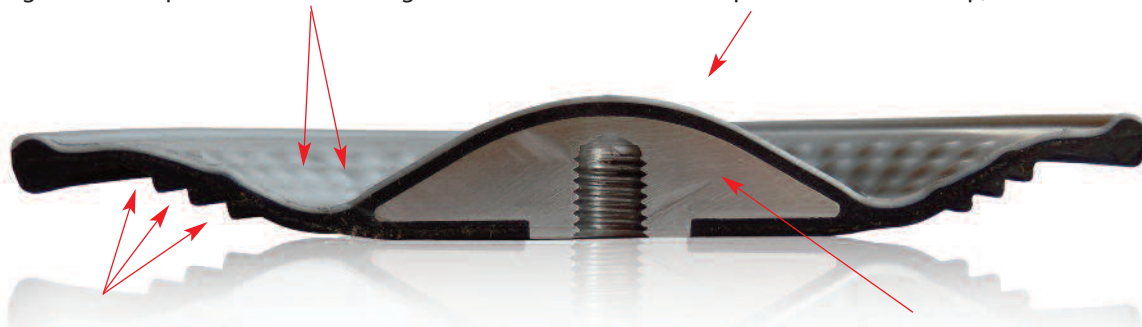

**Innovative diaphragm support side**, offers flexibility, long life and protects from cavitation

**Special internal plate** supports your diaphragm in every movement

## Technical data

ATEX certification	II 2 GD c IIB T4
Construction materials	AISI 316 electropolished
Diaphragms	NBR Conductive EPDM Conductive Compound PTFE+Back up EPDM Conductive Compound PTFE A+Back up EPDM Conductive
Intake/delivery connections	DN 40 Triclamp
Air connection	½"
*Max. self-priming capacity	4 m
*Max. flow rate	175 l/min
Max. head	70 m
Max. air supply pressure	7 bar
Diameter	3,5 mm
Max. operating temp.	95°C with Metallic center block 130°C
Weight	14,0 kg

\* The curves and performance values refer to pumps with submerged suction and a free delivery outlet with water at 20°C, and vary according to the construction material.

## Performance

### RUBY 025 - FULL CAPACITY PTFE - A FITTED

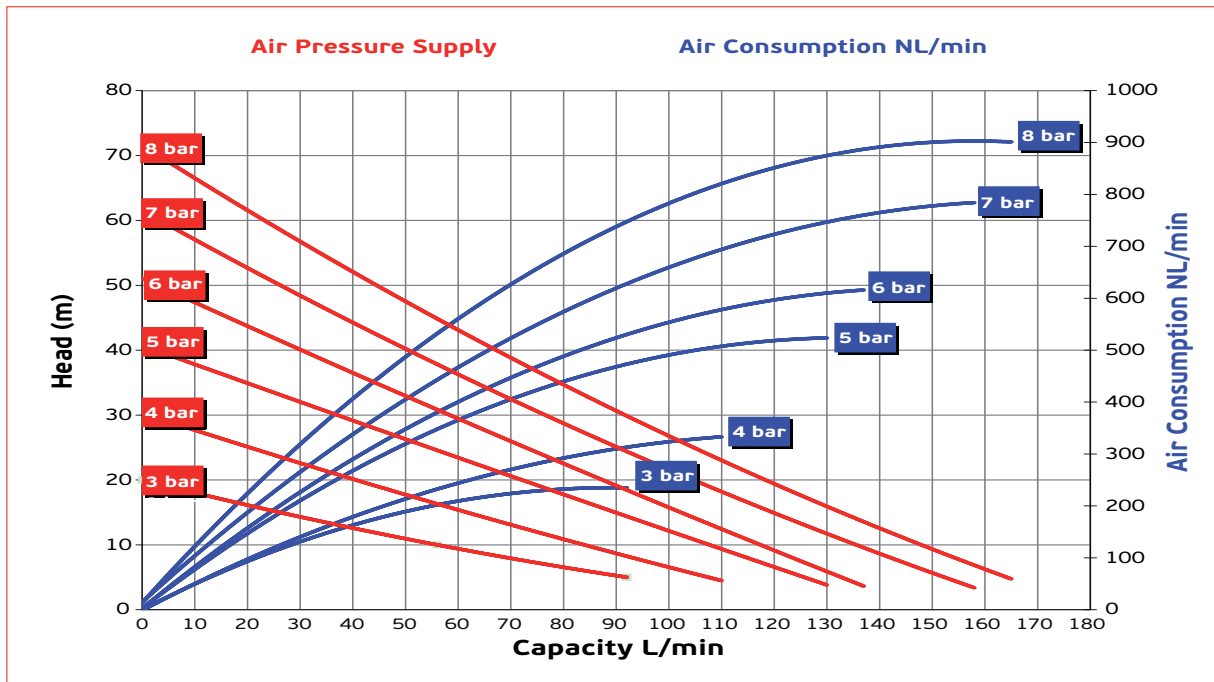

### RUBY 025 - RUBBER FITTED

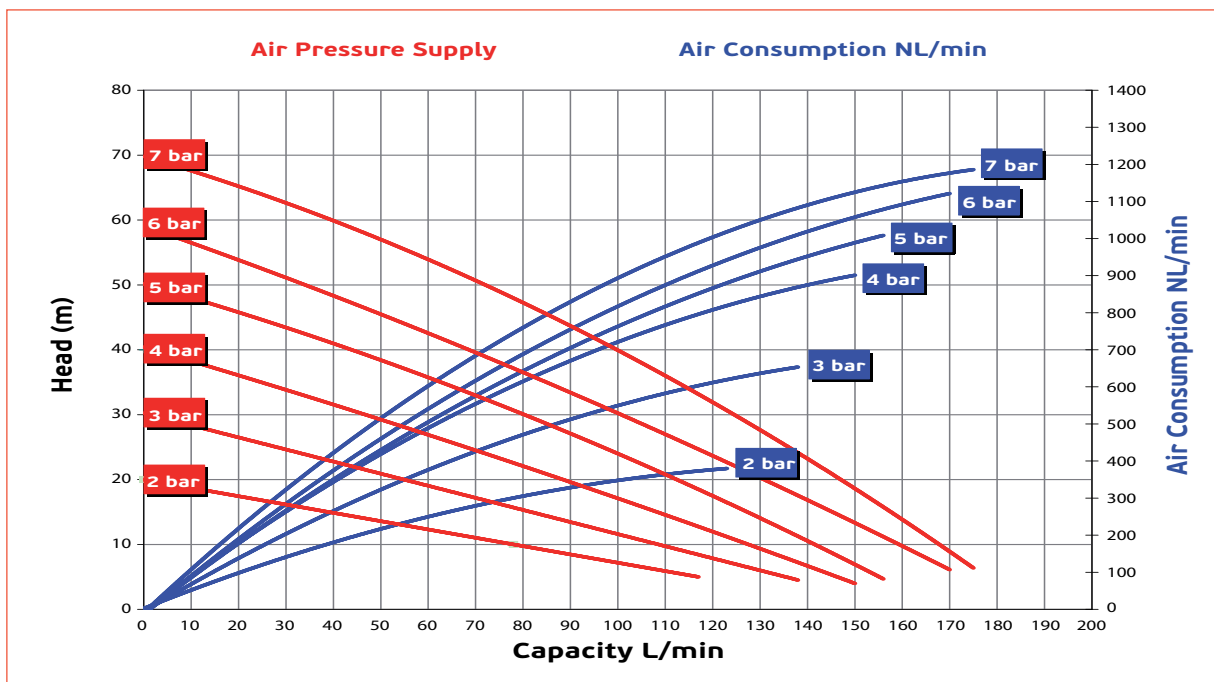

## Performance

### RUBY 025 - PTFE FITTED

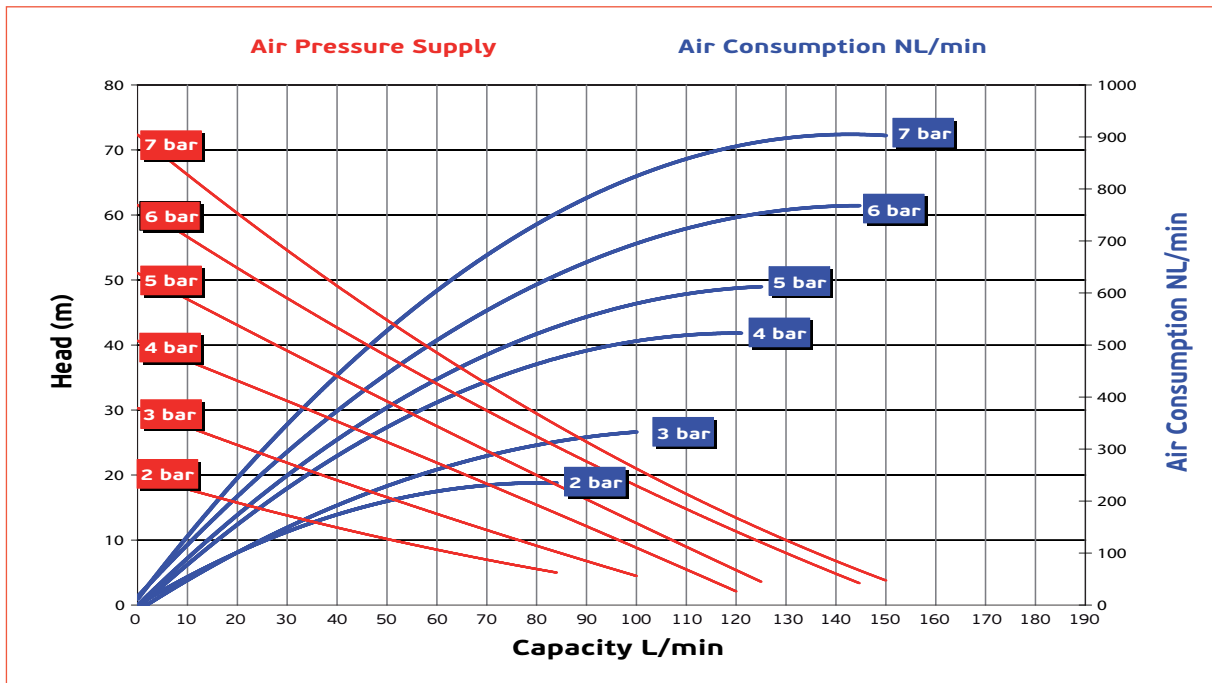

## Dimensions

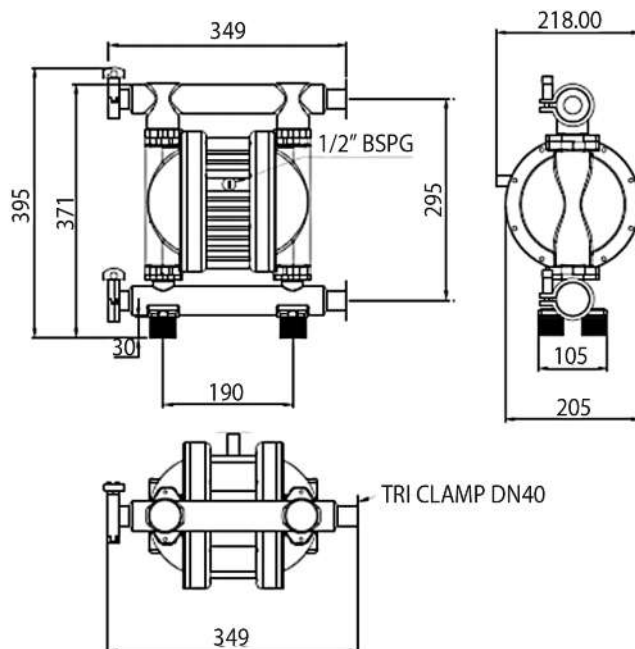

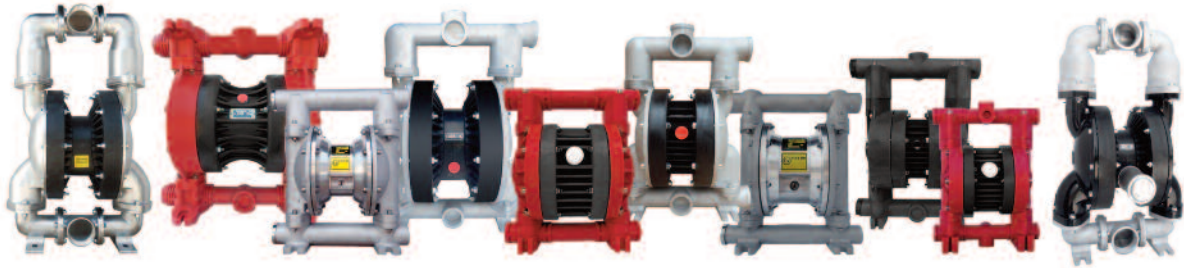

## ALPHADYNAMIC PUMPS Co

### England Sales office:

Rockleigh House, 37 Burton Road  
Ashby de la Zouch, Leicestershire  
LE65 2LF - United Kingdom (UK)  
Registered in ENGLAND & WALES  
Registration number 09706219 - VAT No.GB220393343  
Tel +44 1213 680 324, +44 1213 680472  
email:sales@alphadynamicpumps.co.uk  
www.alphadynamicpumps.co.uk

### Hellas Production Facilities Unit 1

3 Eleftherias Str Industrial Park of Kifisia  
14564 - Kifisia - Hellas  
VAT No. EL 999695309  
Tel +30 210 4200 338, +30 210 4200 422  
Fax +30 211 268 68 37  
email: info@alphadynamic.eu  
www.alphadynamic.eu

### Hellas Production Facilities Unit 2

30 Seneka str Industrial Park of Kifisia  
14564 - Kifisia - Greece  
Tel +30 215 215 9152  
email: sales@rubypump.com